

Liquid level detection in standard capacity measures with computer vision

T. Mušič, G. Bobovnik, J. Kutin

*University of Ljubljana, Faculty of Mechanical Engineering,
Laboratory of Measurements in Process Engineering*

Purpose and requirements

Used for:

- Performing measurements in inaccessible places
- Automating measurements

Requirements:

- Accuracy of manual reading
- Simple to setup

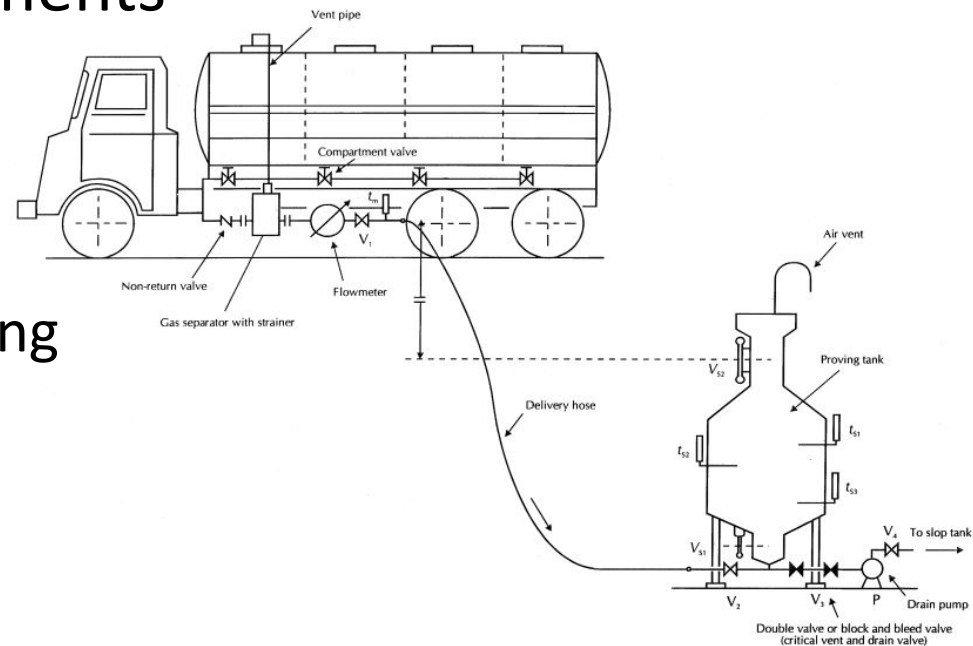

Testing setup

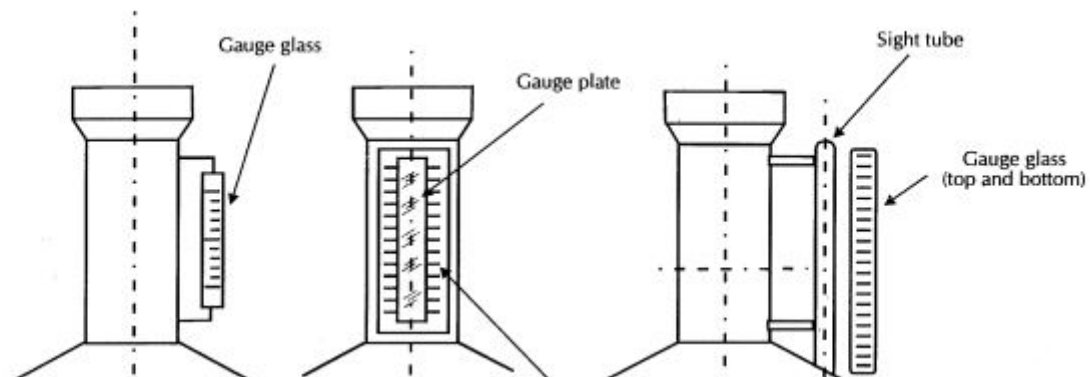
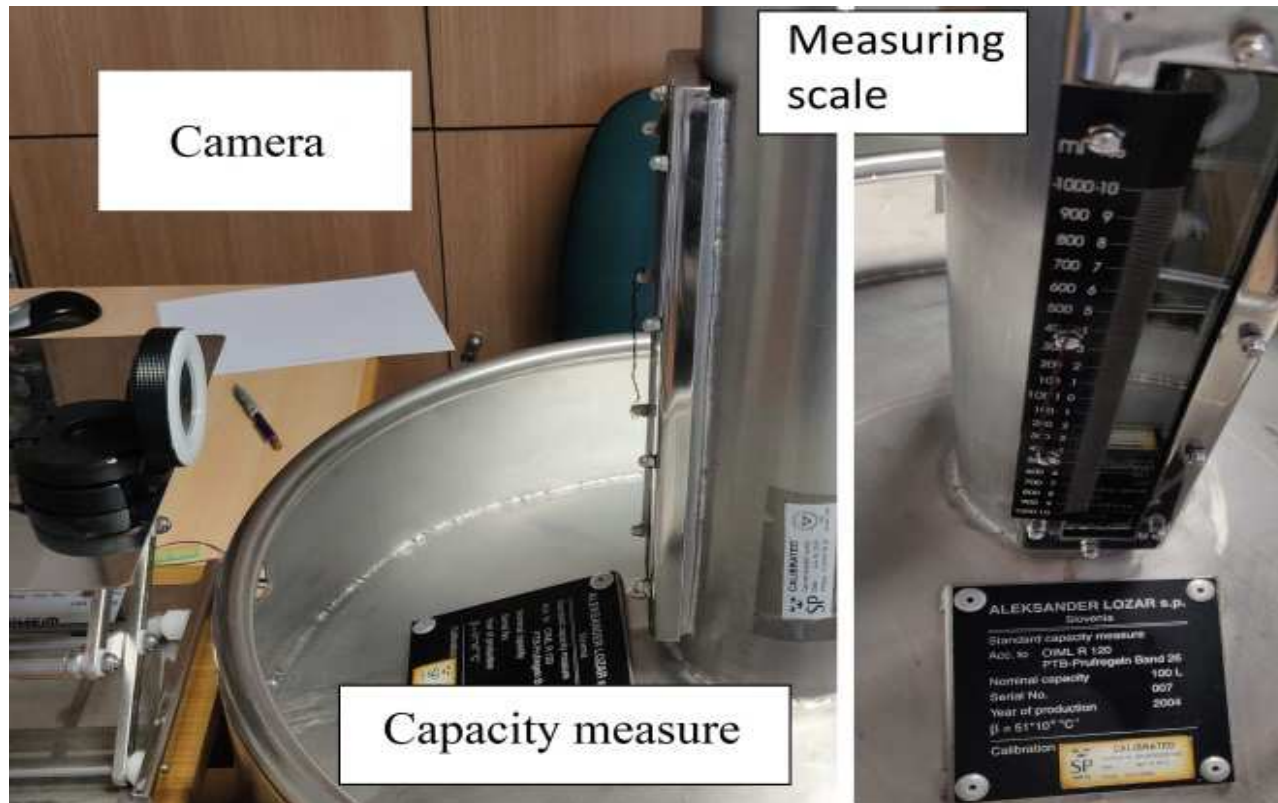

Program

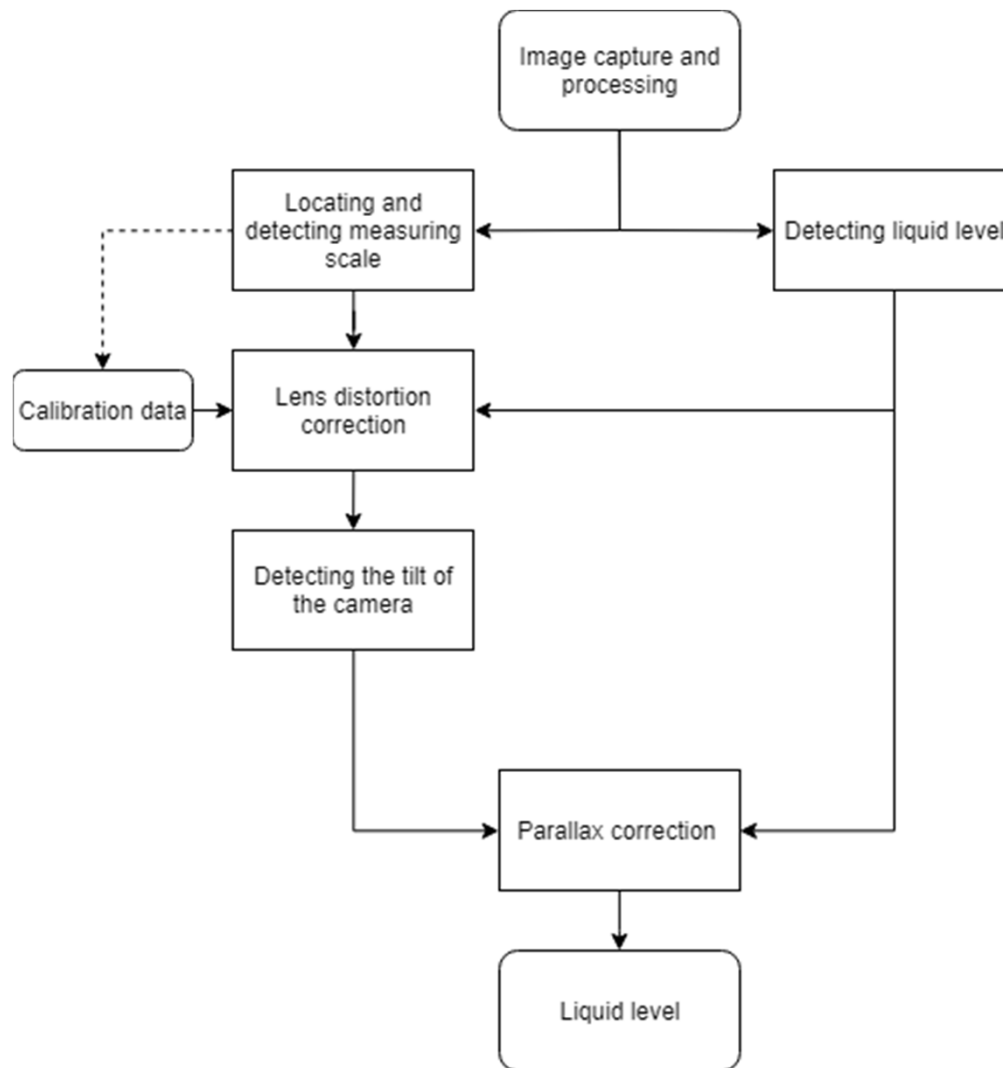

Measuring scale and liquid level detection

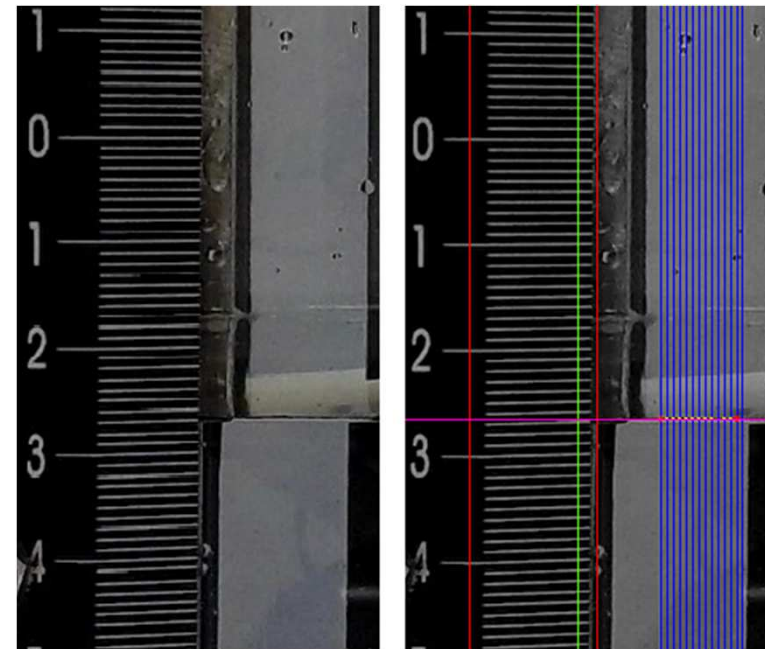
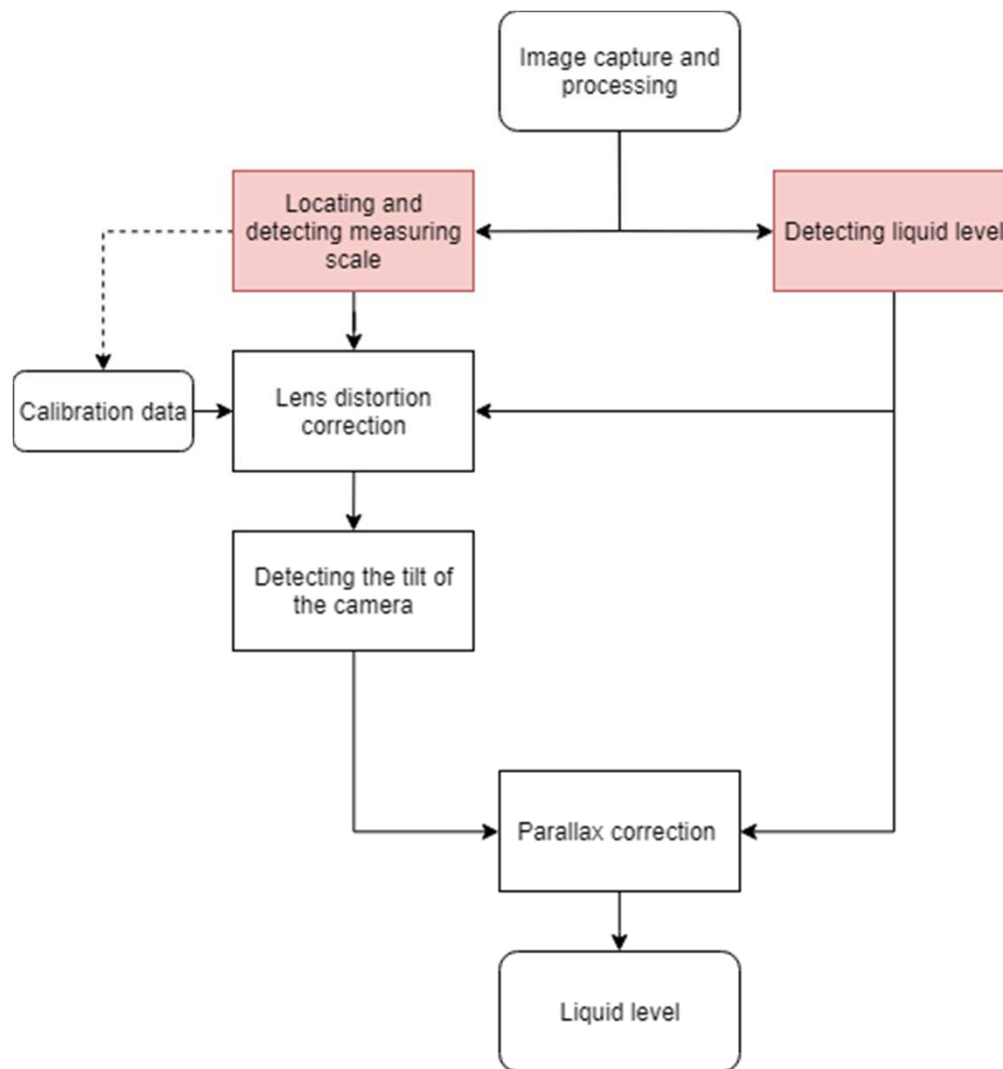

Lens distortion correction

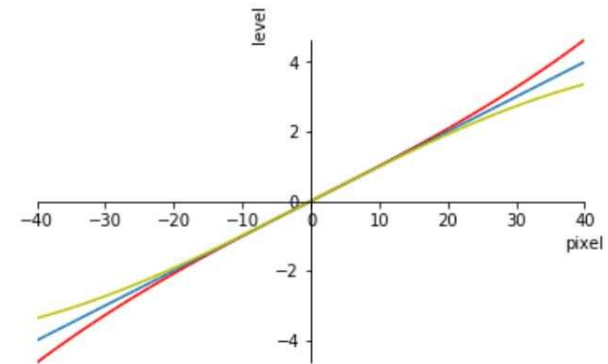
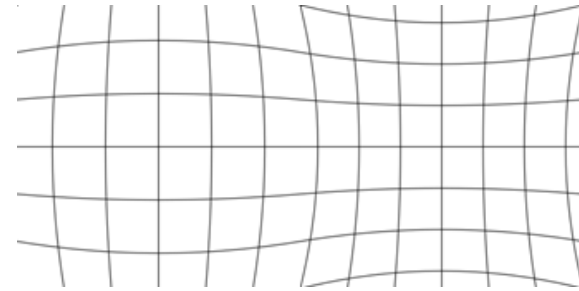
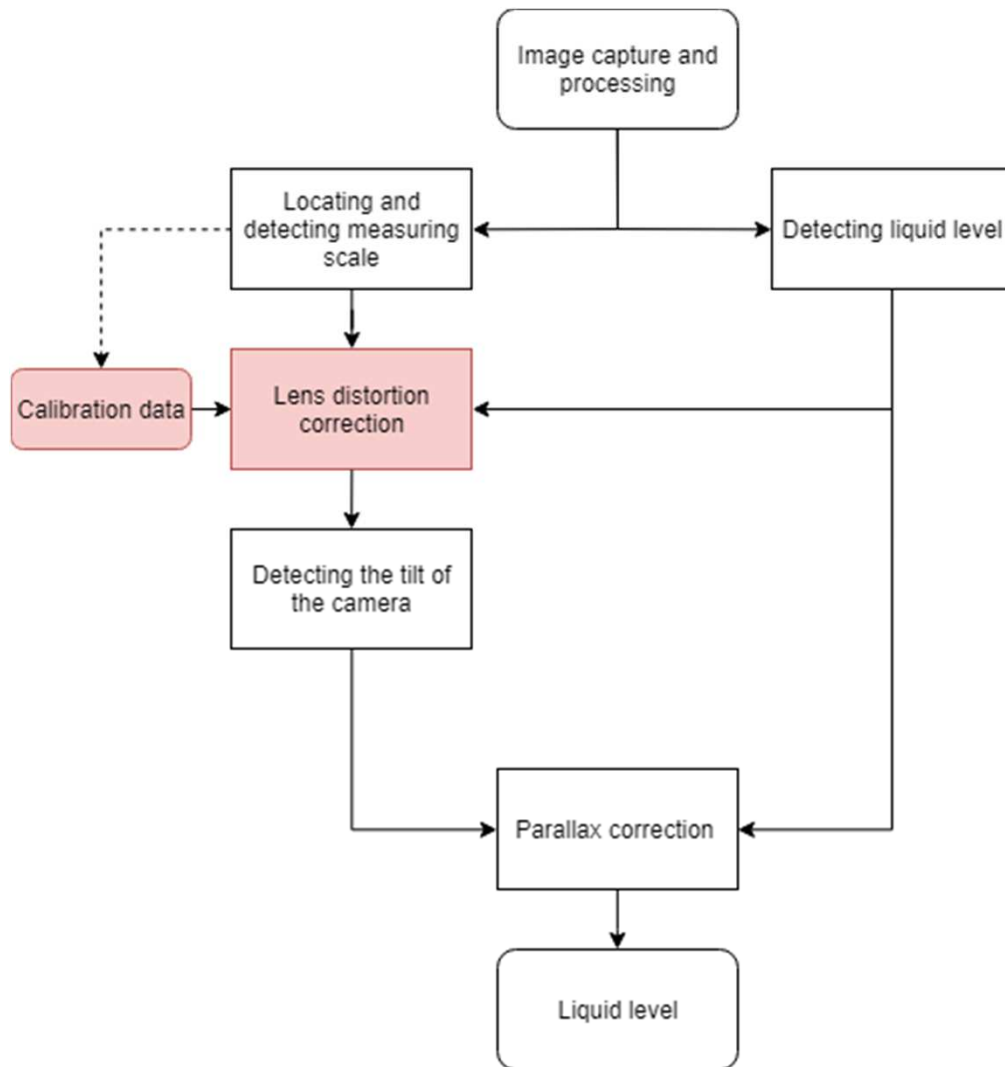

Camera tilt

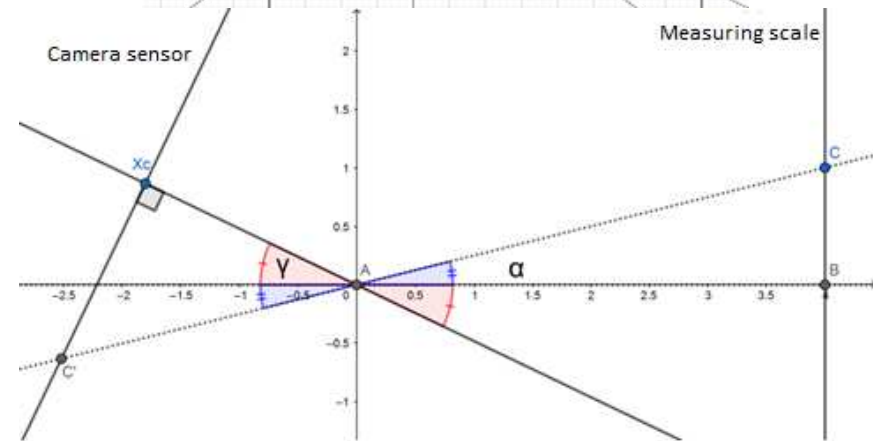
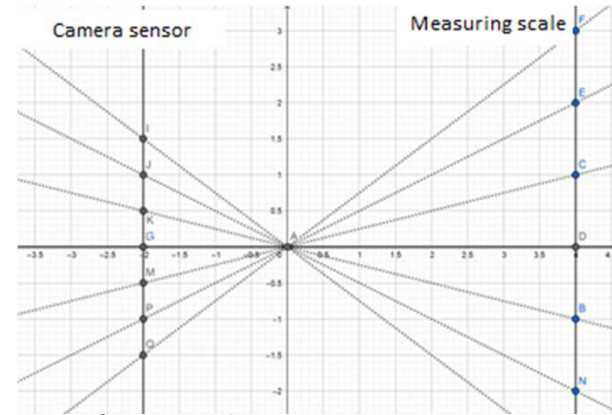
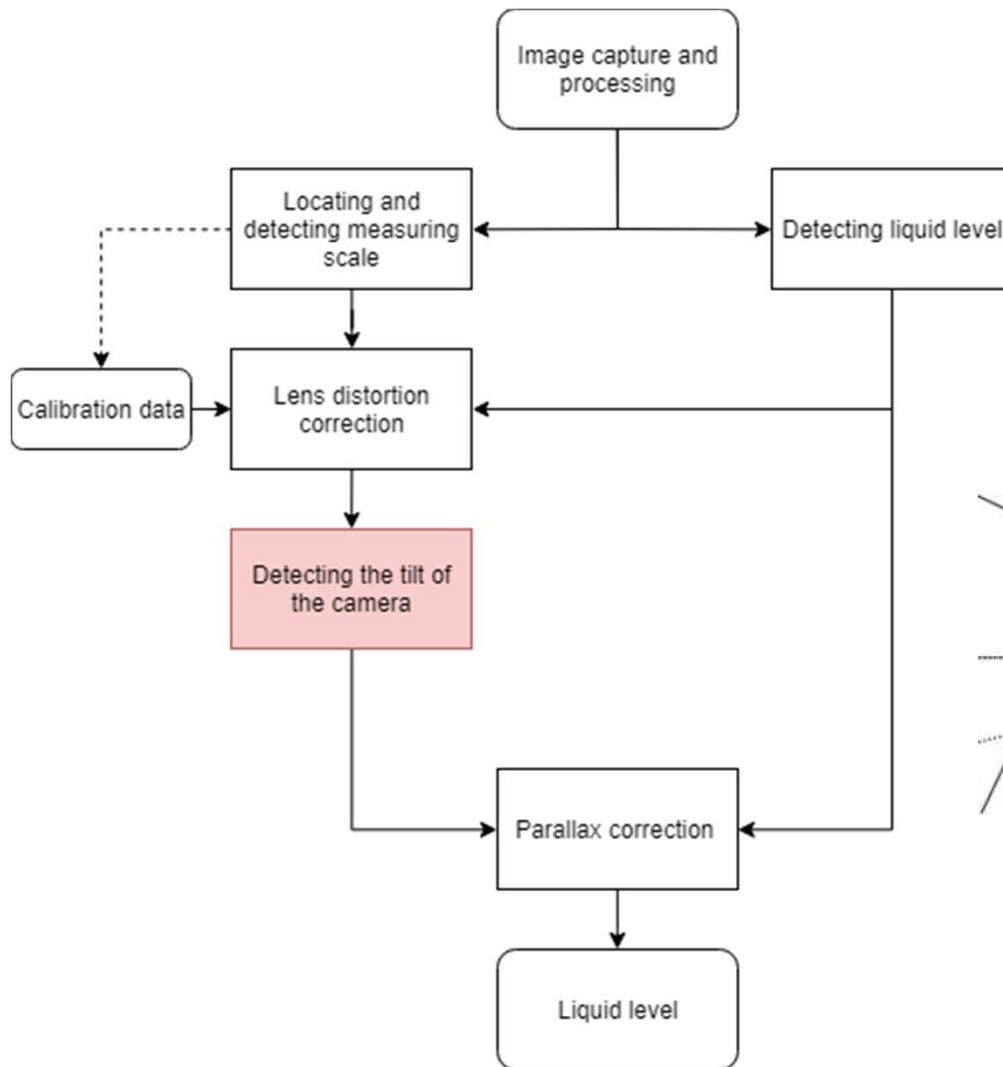

$$L = \frac{\tan\left(\arctan\left(\frac{r}{f}\right) - \gamma\right) s}{R} + LS$$

Parallax correction

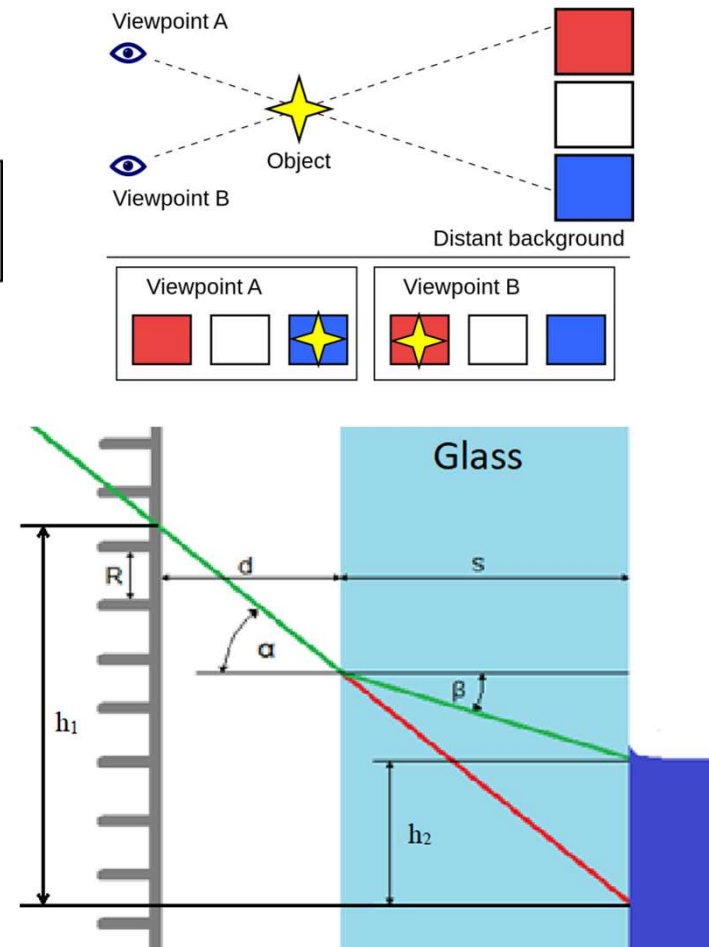
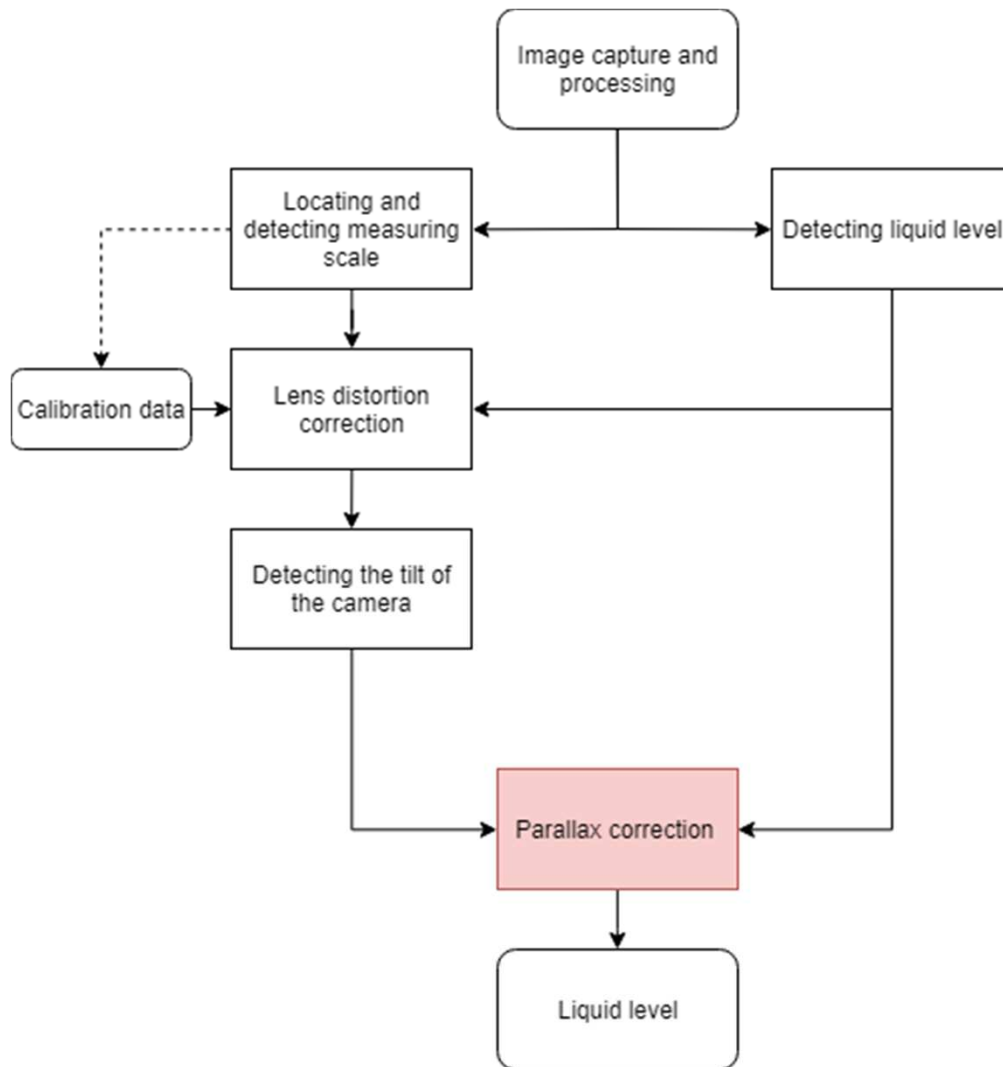

Testing and results

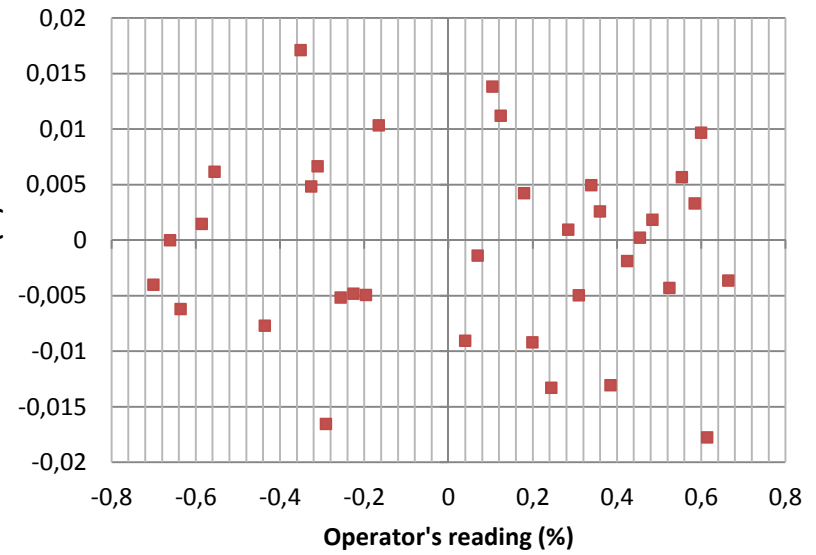

Conclusions

- Systems has satisfied our requirements
- Suitable for transparent liquids
- Dependent on good lightning

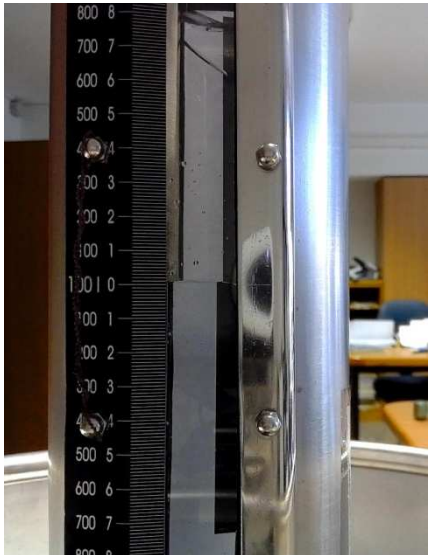

References

- OIML R120: *Standard capacity measures for testing measuring systems for liquids other than water*, 2010.
- Szeliski, R., *Computer Vision: Algorithms and Applications* (Springer), 2010.
- Hornberg, Alexander., *Handbook of Machine Vision* (Wiley-VCH-Verl.), 2011.